	Interface Specification YLP series Ytterbium Pulsed Fiber Lasers Interfaces “type D” and “type D1”	Spec: Revision: Date: Page:	E27043 02 16.01.09 1 of 29
-----------------------------------------------------------------------------------	-------------------------------------------------------------------------------------------------------------------	--------------------------------------	-------------------------------------

The document describes connection and control basics of pulsed lasers equipped with interfaces “type D” and “type D1” manufactured by IPG Laser GmbH and its sister companies.

Contents:

Laser Internal Structure.....2

Power supply connector.....3

Recommended laser connection diagram.....3

Electrical connection.....4

Control Connector Pin Assignment, DB-25 plug.....6

Digital Control Interface (DB-25) Description.....7

Laser Operation using Digital Interface.....10

Operation Features.....11

Operating modes and options.....13

Control Connector Functionality Extension for “type D1” interface16

Configuration Extension Commands Structure and Signals Description (“type D1” interface).....16

Configuration Extension Command Codes.....17

Configuration Extension Timing diagrams18

RS-232C electrical connector.....20

RS-232C Command Structure Description20

RS-232C Command Codes. Table for monitoring and configuration.22

RS-232C Command Codes. Table for RS-232C control interface mode.....24

RS-232C Command Codes. Table for Extended PRR mode.....24

RS-232C Command Codes. Table for Adjustable Pulse Duration mode.....25

Command “\$4” “Read device status”- return value interpretation.....25

Command “\$10” “Read digital interface DB-25 status”- return value interpretation.....26

Command “\$11” “Read device extended status”- return value interpretation.....27

Operating modes commands.....28

Read options command.....29

Laser Internal Structure.

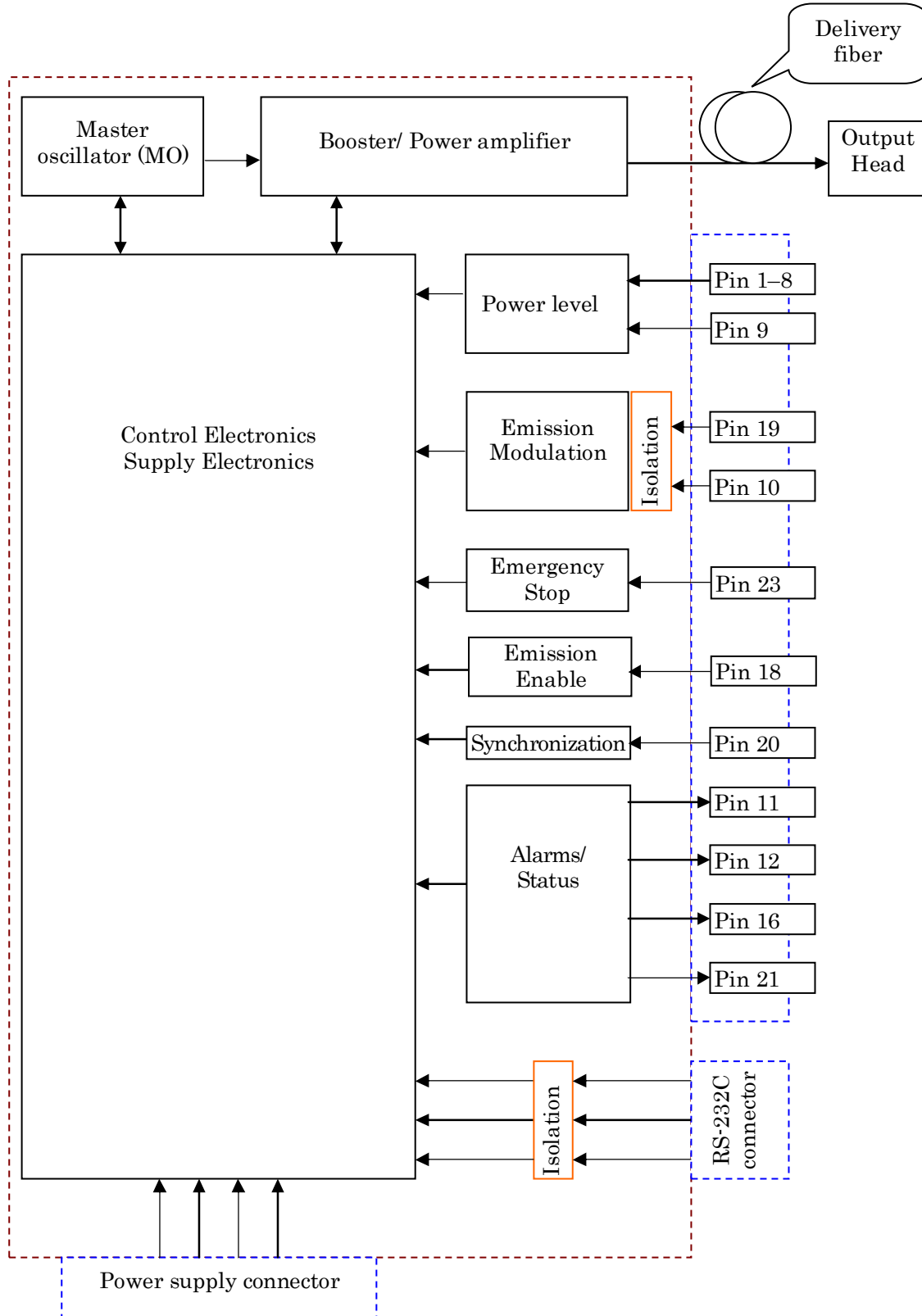

Power supply connector

The power supply connector is the DB-7W2 type plug (male). Pin assignment is shown in the table below.

PIN No.	Name	Level	Description
A1	+24V Supply Voltage	+24VDC	Supply voltage +24VDC $\pm 5\%$. Must be supplied for the full laser operation. Floating power supply is required.
A2	24V Return Wire	Supply Ground	Power supply ground. Inside the laser this ground is connected to the laser internal ground (pin 14 of DB-25 connector). Floating power supply is required.
1, 3, 4	Reserved		Customer connection is not allowed
2	Housekeeping 24V	+24VDC	+24V supply input for independent electronic board and guide laser operation only. Provides no supply to the pump laser diodes. Maximum current is 0.2A. Voltage should be supplied relative to pin A2. Must be supplied for the full laser operation.
5	Case	Earth	Direct electrical connection to the laser housing (module)

Recommended laser connection diagram.

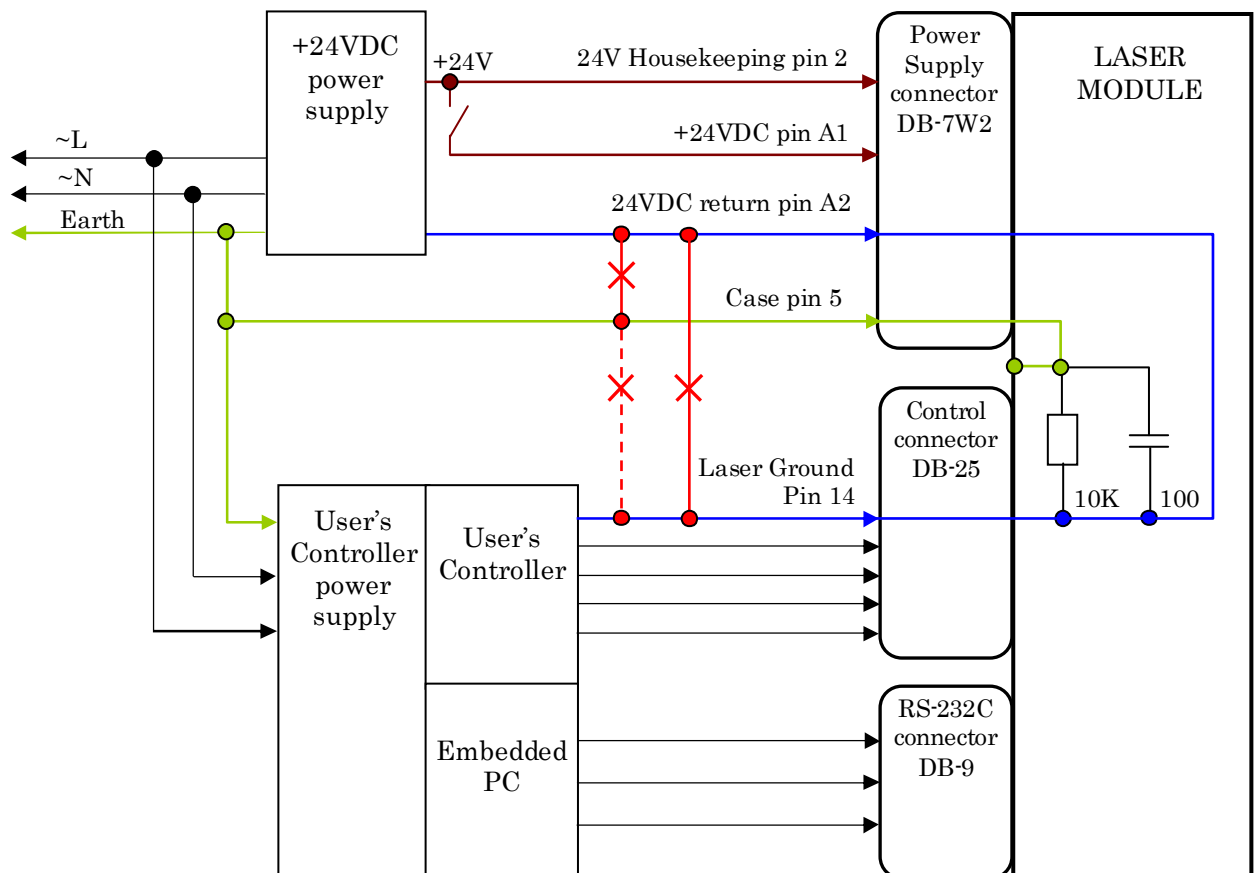

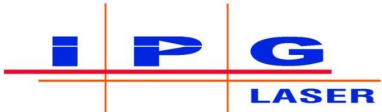
	Interface Specification YLP series Ytterbium Pulsed Fiber Lasers Interfaces “type D” and “type D1”	Spec: Revision: Date: Page:	E27043 02 16.01.09 4 of 29
-----------------------------------------------------------------------------------	-------------------------------------------------------------------------------------------------------------------	--------------------------------------	-------------------------------------

Electrical connection.

1. Main power supply (24VDC) should be capable to permanently supply operating current (refer to the maximum current consumption in the laser specification) and supply 50% higher peak current for short periods up to 250us. Typical models of the laser consume less than 8A current, consequently peak current consumption for such models is less than 12A. Power supply should hold the voltage, measured on the laser cable leads, within a specified range (refer to the laser model specification) both for the steady and for the peak current consumptions. Supply voltage undershoots and overshoots out of the specified range may lead to a non stable laser operation. Power supply transient load regulation should be carefully investigated to choose a suitable power supply model.
2. Wires in the cable connecting main power supply and the laser supply cable should have appropriate length and cross section to ensure negligible voltage drop (especially for the peak current consumption).
3. The main 24VDC supply should have floating outputs. Its return wire should be connected only to the laser 24V return terminal (Pin A2 of DB-7W2). Wrong connections, which may create current loops (shown in the diagram above as the crossed red wires) should be avoided.
4. The main supply line +24V should be connected to +24VDC laser terminal (pin A1 of DB-7W2).
5. Laser ground (DB-25 pin 14) and laser 24V return are connected inside the laser module. No connections are allowed between these terminals outside of the laser module.
6. The laser is equipped with two separate housekeeping supply inputs. The 24V housekeeping is pin 2 of DB-7W2 connector. The 5V housekeeping is pin 17 of DB-25 connector. Table below shows supplies which should be connected to the laser depending on the operating mode.

Operating regime	Main 24V supply	Housekeeping 24V supply	Housekeeping 5V supply
PCB communication guide laser operation no main emission	-	+	- or +
PCB communication guide laser operation no main emission	-	- or +	+
Full operation	+	+	+ or -

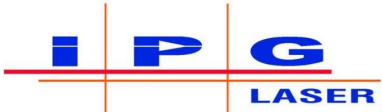
	Interface Specification YLP series Ytterbium Pulsed Fiber Lasers Interfaces “type D” and “type D1”	Spec: Revision: Date: Page:	E27043 02 16.01.09 5 of 29
-----------------------------------------------------------------------------------	-------------------------------------------------------------------------------------------------------------------	--------------------------------------	-------------------------------------

7. In the case of availability both housekeeping supplies the laser consumes power from the 24V housekeeping.

8. Laser warm-up time is calculated from the beginning of supplying a housekeeping voltage. Even if the main +24V supply is disconnected from the DB-7W2 terminal A1, while one or both housekeeping voltages are still available, the main processor of the laser continues to operate. The laser supports communication and keeps all settings made for the current session.

9. Inside the module the common ground is connected to the laser housing via 10 kOhm resistor and parallel 100pF capacitor. This network equalizes potential between ground and the laser case.

10. User controller electronics ground may be connected to the earth by design (dashed red line on the diagram). If there is no such connection, it should not be intentionally made.

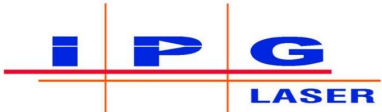
	Interface Specification YLP series Ytterbium Pulsed Fiber Lasers Interfaces “type D” and “type D1”	Spec: Revision: Date: Page:	E27043 02 16.01.09 6 of 29
-----------------------------------------------------------------------------------	-------------------------------------------------------------------------------------------------------------------	--------------------------------------	-------------------------------------

Control Connector Pin Assignment, DB-25 plug.

All control pins are TTL compatible, unless otherwise noted in the pin description. For the interface designs level ranges of the TTL standard should be taken into consideration.

PIN No.	Name	Description
1-8 (D0-D7)	Power Setting	8-bit bus. 0-FFh in hexadecimal or 0..255 in decimal formats. Least significant bit (lsb) (D0) corresponds to Pin number 1, Most significant bit (msb) (D7) corresponds to pin 8. 00h (0): Minimum output power FFh (255): Maximum output power Disconnected corresponds to 00h.
9	Latch	Latches power setting into the laser by the rising edge
10	Modulation return	Return for Emission Modulation input (pin 19). Galvanically isolated.
11,12,16,21		Laser alarms status (see alarm codes in the table below).
13, 24, 25		Reserved, customer connection is not allowed.
14	Ground	Ground
15		+5VDC output. Maximum load is 25 mA.
17	5V house-keeping	+5±0.25VDC power supply input for independent operation of the guide laser and PCB. Maximum current consumption is 0.5A.
18	EE	Emission Enable (EE) signal. HIGH: Emission Enable LOW or disconnected: Emission Disable
19	EM	Emission Modulation (EM) input. Galvanically isolated. HIGH (>3V): Emission ON LOW or disconnected (<1V): Emission OFF
20	Sync	Pulse Repetition Rate (Synchronization) input, square wave.
22	Guide	Guide Laser (red diode) ON/OFF input. Additional functionality for type D1 interface (see corresponding section). HIGH: ON LOW or disconnected OFF
23	EStop	Emergency Stop Input HIGH: OK (Normal operation) LOW or disconnected: STOP (Laser automatically switches OFF MO and Booster)

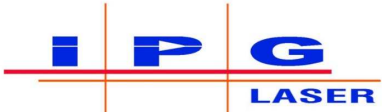
	Interface Specification YLP series Ytterbium Pulsed Fiber Lasers Interfaces “type D” and “type D1”	Spec: Revision: Date: Page:	E27043 02 16.01.09 7 of 29
-----------------------------------------------------------------------------------	-------------------------------------------------------------------------------------------------------------------	--------------------------------------	-------------------------------------

Digital Control Interface (DB-25) Description.

- The laser is controlled via signals applied to the DB-25 connector. Please refer to the connector interface description table above for pin designation and operating levels.
- Pins 1 to 8 are the 8 bit bus for the output power setting. Pin 1 is the least significant bit and pin 8 is the most significant bit. Codes in the range 0...255 (0...FFh) should be applied to these pins, which correspond to the power setting of 0...100% of the specified nominal value.

Note: optical output power is directly proportional to the power setting (see specification for the power adjustment range).

- Pin 9 is the “Latch” control line to store power settings (pin1-8) into the laser. The data is stored to the laser by the rising edge of the signal on the pin 9. Data on the pins 1-8 should be stable for 1 μ s before and 1 μ s after the rising edge on pin 9.

Stability of the data on the Pin 1-9 out of the above mentioned time frames is not required. IPG recommends supplying single positive pulse with duration longer than 2 μ s to latch the data into the laser. Time interval between adjacent latching pulses should be longer than 100 μ s (latching frequency less than 10kHz).

- Pins 11, 12, 16 and 21 are the alarm and status outputs. Pin 12 is reserved for future alarm codes expansion. These pins indicate the following device states:

Pin 12	Pin 11	Pin 16	Pin 21	Alarm description
X	LOW	LOW	LOW	Temperature alarm Laser temperature is out of the operating temperature range.
X	HIGH	LOW	LOW	Power supply alarm External supply voltage is out of the specified range.
X	LOW	LOW	HIGH	Normal operation
X	HIGH	LOW	HIGH	Laser is not ready for emission
X	LOW	HIGH	LOW	Back reflection alarm Laser automatically switches OFF due to high optical power reflected back to the laser.
X	HIGH	HIGH	LOW	Reserved
X	LOW	HIGH	HIGH	System alarm Laser protection system detects internal failure.
X	HIGH	HIGH	HIGH	Reserved

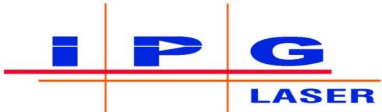
	Interface Specification YLP series Ytterbium Pulsed Fiber Lasers Interfaces “type D” and “type D1”	Spec: Revision: Date: Page:	E27043 02 16.01.09 8 of 29
-----------------------------------------------------------------------------------	-------------------------------------------------------------------------------------------------------------------	--------------------------------------	-------------------------------------

In the case of any alarm the laser will be automatically switched OFF and sets internal Alarm flag. To continue operation after alarm event the internal Alarm flag should be reset. To reset Alarm flag pin 18 and 19 should be set to LOW. Alarm outputs (pins 11, 12, 16 and 21) will be recovered to the normal state simultaneously with the reset of Alarm flag signal (except Back Reflection alarm).

Back reflection alarm: Alarm flag may be dropped when at least one second passes after the alarm activation. If reset was done earlier, the flag will be dropped when 1 second passes after alarm activation.

Laser is not ready for emission state: Laser is not ready to emit power. That may be a result of Emergency Stop and Guide Laser activation without following reset or external power supply voltage out of specified range.

5. Pin 15 provides +5VDC output with current up to 20mA that can be used for auxiliary supplying user electronics communicating with the laser DB-25 control interface.
6. Pin 17 is the input for +5V Housekeeping power supply voltage. The customer may supply $+5\pm 0.25V$ to this pin to operate the laser control electronics (e.g. communication via RS-232C or device configuration) and activate the guide laser (red diode) if installed. The guide laser can operate without any of +24V Main supply or +24V Housekeeping supply connected.
7. Pin 18 is the Emission Enable (EE) signal. The Emission Enable input should be switched ON at least 5ms before switching ON the Emission. After switching ON Emission Enable input, the laser starts to consume more electrical power and emits residual optical power to the output even when EM pin 19 is LOW (Emission). The optical power value (pulsed and CW parts) depends on model and operating mode of the laser. High contrast (HC option) ensures low residual optical power.

Note: the EE switches ON simultaneously with the rising edge on the pin. If the HIGH level was applied to the pin before supplying electrical power to PCB, the laser does not recognize that EE has ON state. In order to enable emission the pin 18 (EE) should be dropped and set to HIGH level again after completing of warm-up phase. If the pin 19 (EM) was also in the HIGH state before supplying power to PCB it should be also dropped to the LOW state at the same time.

8. Pin 19 is the Emission Modulation (EM) control input. This input is galvanically isolated from the other interface inputs. Use pin 10 (modulation return) as the return wire for this signal. Apply HIGH to switch ON the Emission and LOW to switch it OFF. The laser starts

	Interface Specification YLP series Ytterbium Pulsed Fiber Lasers Interfaces “type D” and “type D1”	Spec: Revision: Date: Page:	E27043 02 16.01.09 9 of 29
-----------------------------------------------------------------------------------	-------------------------------------------------------------------------------------------------------------------	--------------------------------------	-------------------------------------

to emit optical power within specified delay after setting the pin to the HIGH level and stops to emit with specified delay after setting to the LOW level. Refer to the laser optical specification for the laser average power rise and fall times. Modulation with a period shorter than sum of the rise and fall times (the laser response time) may lead to the non adequate laser power behavior and optical over/undershoot.

Note 1: the EE input should be switched ON at least 5ms before switching ON the Emission. In case of switching ON EM while the EE is OFF, the laser does not start to emit. In case of switching ON the EM and later the EE, the laser starts to emit in less than 5ms after switching ON the EE.

Note 2: Emission switches ON simultaneously with rising edge on the pin. If the HIGH level was applied to the pin before supplying voltage to the PCB, the laser does not recognize that as the Emission switching ON signal. The pin should be dropped and set to HIGH level again. If the pin 18 was also in the HIGH state before supplying voltage to the PCB it should be also dropped at the same time.

9. Pin 20 is the Synchronization input. Pulse train with a repetition rate (PRR) within specified operating range should be applied to the pin (refer to the optical specification for PRR limits). The laser emits pulses simultaneously with the rising edge of the signal. The square wave input signal with duty cycle 0.1 to 0.9 is allowed. Variation of the duty cycle does not affect to the laser characteristics.

Note: In case of the PRR supplied being out of the specified range (or no PRR signal supplied) the laser safety circuit substitutes missing pulses or limits the PRR.

10. Pin 22 is the guide laser (red diode/ pointer) control line. Apply HIGH to switch the guide laser ON and LOW to switch the guide laser OFF. If the guide laser option is not installed, pin 22 can either be connected to ground (pin14) or left floating.

Note: the laser emission is not allowed simultaneously with the guide laser operation. MO and Booster are blocked internally during the guide laser operation. If the Emission Modulation (pin 19) or Emission Enable (pin18) were set to HIGH level during guide laser operation, the laser will not emit power, and will not start to emit it even after switching OFF the guide laser. It is necessary to drop both Emission Modulation (pin 19) and Emission Enable (pin 18) to restart the laser emission. Until the restart is done the state “Laser is not ready for emission” will be active on appropriate alarm/status pins.

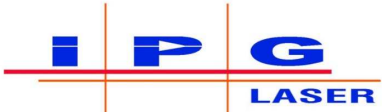
	Interface Specification YLP series Ytterbium Pulsed Fiber Lasers Interfaces “type D” and “type D1”	Spec: Revision: Date: Page:	E27043 02 16.01.09 10 of 29
-----------------------------------------------------------------------------------	-------------------------------------------------------------------------------------------------------------------	--------------------------------------	--------------------------------------

- Pin 23 is the “Emergency stop” input. It should be set to HIGH for normal operation. In case of dropping this pin to LOW state (even for a short period) the laser automatically switches OFF (similar state when both EE and EM are OFF) independently of other control signals. It is necessary to drop both EE and EM pins (if they were in HIGH state) to restart laser operation. Until the restart is done state “Laser is not ready for emission” will be active on appropriate alarm/status pins. Pin 23 should be set to HIGH at least 2 μ s before supplying ON signals to EE and EM pins.

Laser Operation using Digital Interface.

- Remove the protection cap from the laser output optical head and make the appropriate termination.
- Connect the laser module to the control system via DB-25 connector. Use pins according to the description above.

Note: Described laser interface is not compatible with the IPG old type “Remote control” drivers. Consult IPG concerning suitable model of remote control.

- Recommended initial state of control pins:
 - Pins 18, 19, 22 are LOW
 - Pin 23 HIGH
 - Pin 20 with repetition rate within specified range
- Connect power supply sources (housekeeping and main) to the laser as described above.
- In 10 seconds after supplying +24V or +5V housekeeping voltages (warm-up time) the laser is ready for operation.

Note: It is allowed to supply +24V or +5V Housekeeping voltage before initialization of the control signals.

- Set desired power via pin 1-8. Apply the latch pulse to the pin 9 to store the power settings into the laser.
- Switch the EE ON applying HIGH to the pin 18.
- Wait 5ms.

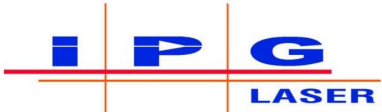
	Interface Specification YLP series Ytterbium Pulsed Fiber Lasers Interfaces “type D” and “type D1”	Spec: Revision: Date: Page:	E27043 02 16.01.09 11 of 29
-----------------------------------------------------------------------------------	-------------------------------------------------------------------------------------------------------------------	--------------------------------------	--------------------------------------

9. Laser is ready for fast modulation via Pin 19. It is possible to apply HIGH and LOW sequence to switch the laser ON and OFF correspondingly. The laser has finite ON/OFF rise/fall times (refer to the specification for the particular model). The speed of the modulation should not be faster than sum of rise and fall times, otherwise laser optical response may not be as expected.
10. If the EM OFF time between subsequent ON/OFF batches (jobs) is more than 500ms, it is recommended to switch OFF the Emission Enable pin. This will spare power consumption, avoid unnecessary wear out of the laser and exclude residual MO power at the laser output.
11. After finishing laser operation, switch OFF the EM and EE (set LOW to pin 18 and pin 19).
12. Remove all supply voltages.

Operation Features.

1. PRR can be changed during laser operation by the adjustment of the signal frequency at the pin 20. The laser has its own internal frequency generator to ensure correct optical PRR for driving MO. Internal generator is a “slave” circuit, that controlled by a “master” pulses applied to the pin 20. Control circuit attempts to synchronize frequency and phase of “slave” pulses with “master” pulses by an appropriate frequency tuning of internal generator. When synchronization pulses of a stable frequency within specified frequency range are applied to the pin 20, the laser synchronizes frequency and phase of the optical pulses with the “master” pulses at the pin 20.
2. Operation of the internal “slave” generator is different for “Type D” “Type D1” interfaces.

Type D.

For the interface “Type D” a phase locking loop circuit attempts to compensate a delay between the supplied “master” pulses and the output optical pulses. Changing of the “master” pulses PRR causes tuning of the internal generator frequency and a drift of optical PRR to the new “master” frequency. There are two modes of the tuning depending on “Jump PRR” configuration state.

Jump PRR is active. If the period of the “master” pulses is changed by less than 1us, the internal “slave” generator adjusts its period with speed of 10 ns per “master” pulse. If the period of “master” pulses is changed by more than 1us, the laser switches OFF emission for 4 pulses and restores it with the “slave” generator operating at the new

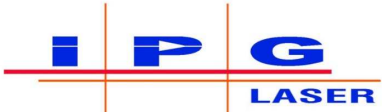
	Interface Specification YLP series Ytterbium Pulsed Fiber Lasers Interfaces “type D” and “type D1”	Spec: Revision: Date: Page:	E27043 02 16.01.09 12 of 29
-----------------------------------------------------------------------------------	-------------------------------------------------------------------------------------------------------------------	--------------------------------------	--------------------------------------

PRR. Delay compensation between “master” and “slave” generators follows this PRR jump and runs a with speed of 10ns per pulse. This frequency/phase locking mechanism provides stable laser operation and protects the laser from a random or a missing input signal on pin 20.

Jump PRR is not active. Phase locking loop starts to synchronize frequency and phase of the “master” and “slave” generators. The speed of the PRR drift equals to 10ns per “master” pulse period. This mechanism ensures smooth PRR tuning from a previous PRR to the final one.

Type D1.

For interface “type D1” PRR of the “slave” internal generator is synchronized by the phase locking loop with the external “master” instantly. There is only a constant delay between the electrical “master” pulses and the output optical pulses; it can vary unit to unit, but stays in range 0.1÷3μs range.

3. If the “master” PRR (pin 20) is higher than the maximum allowed PRR, the laser will operate at the maximum specified PRR. If the “master” PRR (pin 20) is lower than the minimum allowed PRR, the laser will operate at the minimum specified PRR.
4. The power setting can be changed during the laser operation by applying updated levels to pin 1-8 and latching them into the laser via pin 9. Laser response time to the power setting change is within specified delays for rise/fall times (refer to the laser specification).
5. If pins 18 and 19 are in LOW state, there is no laser radiation at the operating wavelength.
6. If the EE is ON, and the EM is OFF, there is a residual power at the laser output. The value depends on the laser model and the operating mode.
7. If the EE is ON and the EM is ON with the zero power set (all pins 1-8 were LOW during the latching of the power into the laser) there is a residual power at the laser output. The value depends on the laser model and the operating mode.
8. The red diode can be switched ON during laser operation (if the option is installed) using pin 22. The guide laser should be turned ON when the EE and EM pins are OFF. If the one of EE or EM is ON, the emission is automatically stopped. To recover laser operation it is necessary to drop pins 18, 19 to LOW. Switching ON of EE and EM is enable only after setting pin 22 to LOW.

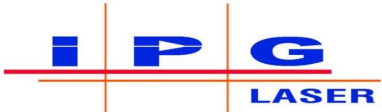
	Interface Specification YLP series Ytterbium Pulsed Fiber Lasers Interfaces “type D” and “type D1”	Spec: Revision: Date: Page:	E27043 02 16.01.09 13 of 29
-----------------------------------------------------------------------------------	-------------------------------------------------------------------------------------------------------------------	--------------------------------------	--------------------------------------

9. The optional guide laser may operate from either the 24VDC or 5VDC housekeeping.
10. Make sure that pin 22 is connected to the ground or left floating if the guide laser is not in use. Connection to the HIGH level disables laser emission.
11. The laser automatically switches OFF emission, if the module temperature rises above or drops below specified maximum/minimum operating temperatures (for operating temperature range refer to the laser specification). The internal Alarm flags set and appropriate alarm signal combination appears on the alarm pins 11, 12, 16 and 21. The laser does not recover the emission and holds the alarm pins unchanged until the reset of Alarm flag is done. For devices with a remote Booster (power amplifier), this also relates to the remote head temperature.
12. The laser has an internal back reflection sensor. It switches emission OFF if the reflected level is potentially dangerous for the laser. The internal Alarm flags is set and the appropriate alarm signal combination appears on the alarm pins 11, 12, 16 and 21. The laser does not recover the emission and holds the alarm pins unchanged until the reset of Alarm flag is done. It is possible to switch ON the EE and EM again in one second after the alarm was emerged.

Operating modes and options

1. The laser may be equipped with options and control modes, which extend and/or change laser operation. List of installed options may be read by RS-232C interface using appropriate command. Below is the options matrix, which shows compatible combinations of modes and options which can be installed in the laser.

Option/ Mode	Description	Customer configurable	Other necessary options
RS-232	RS-232 control interface	yes	no
HC	High Contrast	no	no
ExtPRR	Extended Pulse Repetition Rate	yes	no
BS	Bitstream mode	yes	HC
BS1	Bitstream 1 mode	yes	HC
AdjPulse	Adjustable Pulse Duration mode	no	no
Jump PRR	Jump Pulse Repetition Rate	no	no

Note: for interface “Type D1” modes BS and Jump PRR are not available.

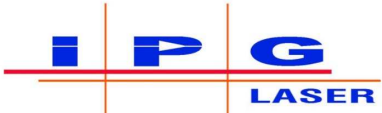
	Interface Specification YLP series Ytterbium Pulsed Fiber Lasers Interfaces “type D” and “type D1”	Spec: Revision: Date: Page:	E27043 02 16.01.09 14 of 29
-----------------------------------------------------------------------------------	-------------------------------------------------------------------------------------------------------------------	--------------------------------------	--------------------------------------

2. **“RS-232C”** option allows controlling the laser via RS-232 port. Without this option RS-232 port can only be used for monitoring of the laser parameters.
3. **“HC”** high contrast option ensures low power leakage if the Emission Modulation signal (pin 19) is LOW and Emission Enable signal (pin 18) is HIGH. For a laser not equipped with this option there is a power leakage at the output,, with the value depending on the model of the laser. If BS1 operating mode is activated, a CW residual power may be emitted.
4. **“ExtPRR”** Extended PRR option allows to operate with the PRR lower than nominal (refer to the specification for details). Average power is proportionally reduced while operating at PRR is less than nominal, so that the pulse energy is kept constant.
5. **“BS”** Bitstream operating mode allows modulation of each pulse individually. Assuming that the laser operates at a constant PRR, the EM signal can be used as a mask. If EM is HIGH the pulse will be emitted at the pulse synchronization signal. If EM is LOW the pulse is not emitted. There is a constant time shift (typically 256μs, may vary depending on the model) between the first rising edge of PRR signal, after the EM signal became HIGH, and the emitted optical pulses train. The option HC is always included, if BS option is installed. An example of a control diagram is shown below.

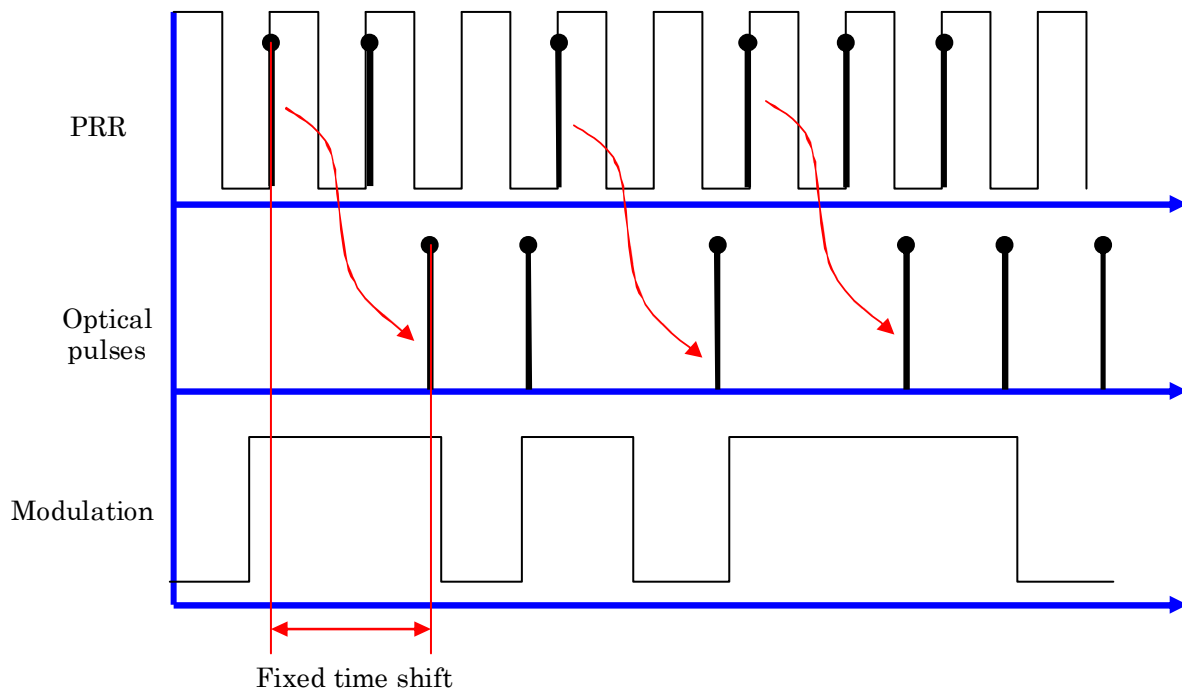

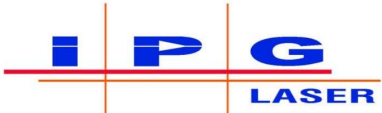
	Interface Specification YLP series Ytterbium Pulsed Fiber Lasers Interfaces “type D” and “type D1”	Spec: Revision: Date: Page:	E27043 02 16.01.09 15 of 29
-----------------------------------------------------------------------------------	-------------------------------------------------------------------------------------------------------------------	--------------------------------------	--------------------------------------

6. **“BS1”** Bitstream 1 operating mode allows modulation of each pulse individually. Assuming that the laser operates at a constant PRR, the EM signal can be used as a mask. If EM is HIGH the pulse will be emitted at pulse synchronization signal. If EM is LOW the pulse is not emitted. There is a small delay typically less than 2 μ s (may vary depending on the model) between the rising edge of PRR signal after the EM signal becomes HIGH and the emitted optical pulse. The option HC is always included, if BS1 option is installed. Sample of a control diagram is shown below. BS1 option (unlike BS) requires the laser to be ready to emission instantly. This results in a leakage of a small amount of CW power in EE ON and EM OFF states. Option BS and BS1 are perfectly fit to raster marking technique. An example of a control diagram for BS1 is shown below.

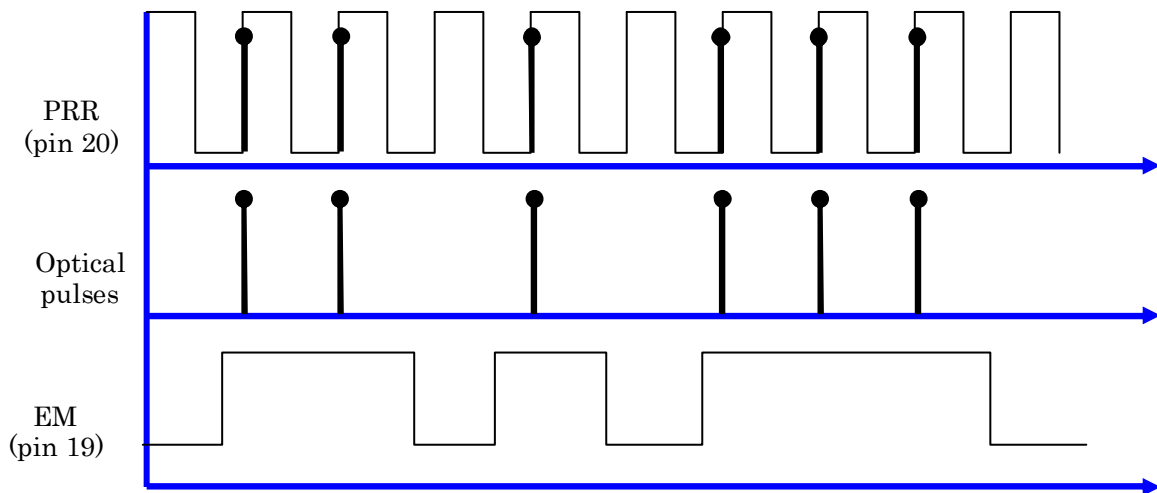

7. **“AdjPulse”** Adjustable pulse duration option allows user to choose shape and duration of the optical pulse from the preinstalled discrete set. The set of preset optical pulse shapes is defined in the device specification and is calibrated at the factory. Please note that operating parameters of the laser like maximum energy and average power may change with the pulse duration (refer to the device specification for detail).

	Interface Specification YLP series Ytterbium Pulsed Fiber Lasers Interfaces “type D” and “type D1”	Spec:	E27043
		Revision:	02
		Date:	16.01.09
		Page:	16 of 29

Control Connector Functionality Extension for “type D1” interface

In the type D1 interface several lines of DB-25 connector may be used for laser parameters setting and monitoring using serial communication. This “Configuration Extension” of digital interface may be activated, deactivated and used as described below. It is designed for instant fast change of some of the laser parameters. It is recommended for use when RS-232 configuration interface is too slow or not convenient for operation.

Note: Control pins used in the “Configuration extension” of the digital interface also retain their main function, e.g. guide laser control for pin 22, during operation.

PIN No.	Name	Description
2	Serial Input	Laser serial data input. Set data bit to the laser synchronously with SCLK rising edge
3	SCLK	Serial data clocks, 100 kHz maximum
14	Ground	Ground
16	Serial Output	Laser serial data output. Get data bit from the laser synchronously with SCLK rising edge
22	Interface Enable	Enable of “Configuration Extension” functionality HIGH: Enabled. Pins used in “Configuration extension” (2, 3, 16) will have double functionality. LOW or disconnected Disabled

Configuration Extension Commands Structure and Signals Description (“type D1” interface)

Use serial input (pin 2) to send commands from the control system to the laser and serial output (pin 16) to receive a reply from the laser. Seed clock signal to pin 3 to use the “Configuration Extension”. All command described below should be sent in binary code and MSB should be transmitted first.

User command structure to send to the laser:



Laser reply structure:

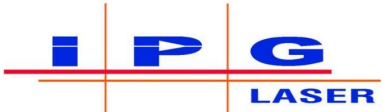

	Interface Specification YLP series Ytterbium Pulsed Fiber Lasers Interfaces “type D” and “type D1”	Spec: Revision: Date: Page:	E27043 02 16.01.09 17 of 29
-----------------------------------------------------------------------------------	-------------------------------------------------------------------------------------------------------------------	--------------------------------------	--------------------------------------

0xA5 (A5h) – is an activation byte that activates “Configuration extension” interface data flow. All subsequent data bits received by the laser Serial Input (pin 2) are recognized according to the command structure described above. Laser sends reply to the Serial Output (pin 16) simultaneously (see timing diagrams below).

The length of a message to the laser is fixed to 4 bytes

The second byte of the message to the laser is a command (for example, 0x01)

The third and the fourth bytes of to the message are parameters (Big endian order if a 16bit word is transmitted).

Interface Enable signal should be set to HIGH for at least 10 μs before the first change of other interface lines and dropped to LOW no sooner than at least 10 μs after the last change of other interface lines.

For all commands device returns a sequence starting with identification byte 0xA5.

Laser Reply Structure starts synchronously with the edge of 9th SCLK signal (see diagrams)

It is recommended to drop EE (pin 18) and EM (pin 19) lines to LOW state before using “Configuration extension” interface.

Configuration Extension Command Codes

Type	Command	Command code	Parameters or return values	Description/Parameters
Write	Set Pulse Width	0x01	Binary, two bytes	Set pulse width in ns
Read	Get Pulse Width	0x02	Binary, two bytes	Get active pulse width

After finishing the procedure of switching pulse duration through 25-pin interface laser starts the internal procedure of initializing internal parameters. Typical duration of this procedure depends on the laser model; maximum value is less than 50 msec.

Note: if the pulse duration sent by 0x01 command is not supported by the laser, it will be ignored. Refer to the laser specification for a list of the acceptable parameters of the laser.

Configuration Extension Timing diagrams

Below is a sample timing diagram for setting the pulse duration to 200ns using command 0x01.

Bytes sequence is as follows:

0xA5/0x01/0x00/0xC8, where 0x00 and 0xC8 represent pulse width in nanoseconds.

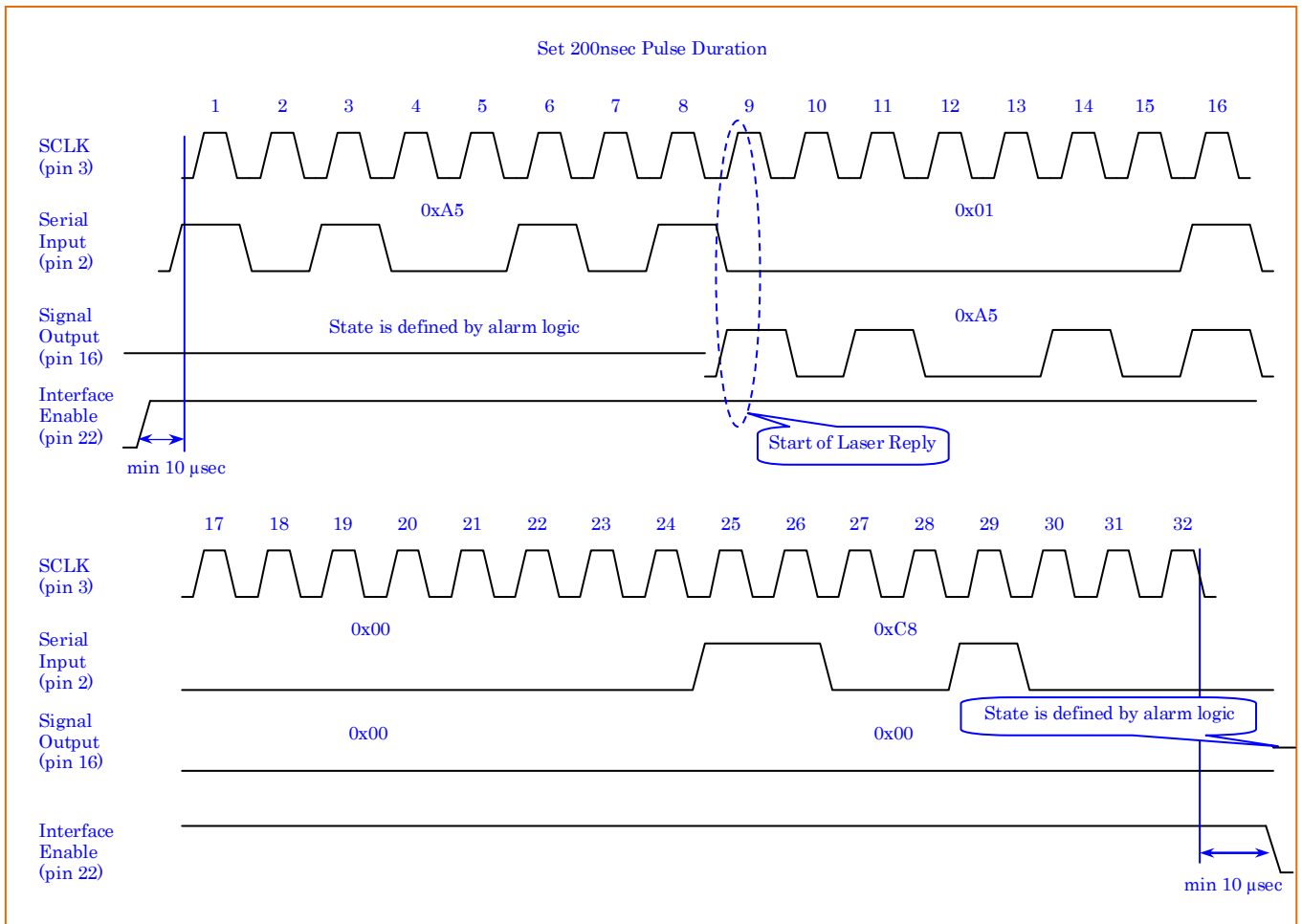

The command parameter is a binary value of pulse width in ns.

The returned value is also a binary value of pulse width in ns.



**Interface Specification YLP series
Ytterbium Pulsed Fiber Lasers
Interfaces “type D” and “type D1”**

Spec:	E27043
Revision:	02
Date:	16.01.09
Page:	19 of 29

Below is a sample timing diagram for reading the pulse duration using command 0x02. Bytes sequence is 0xA5/0x02. Command 0x02 returns sequence 0xA5/0x00/0xC8 corresponding to 200ns.

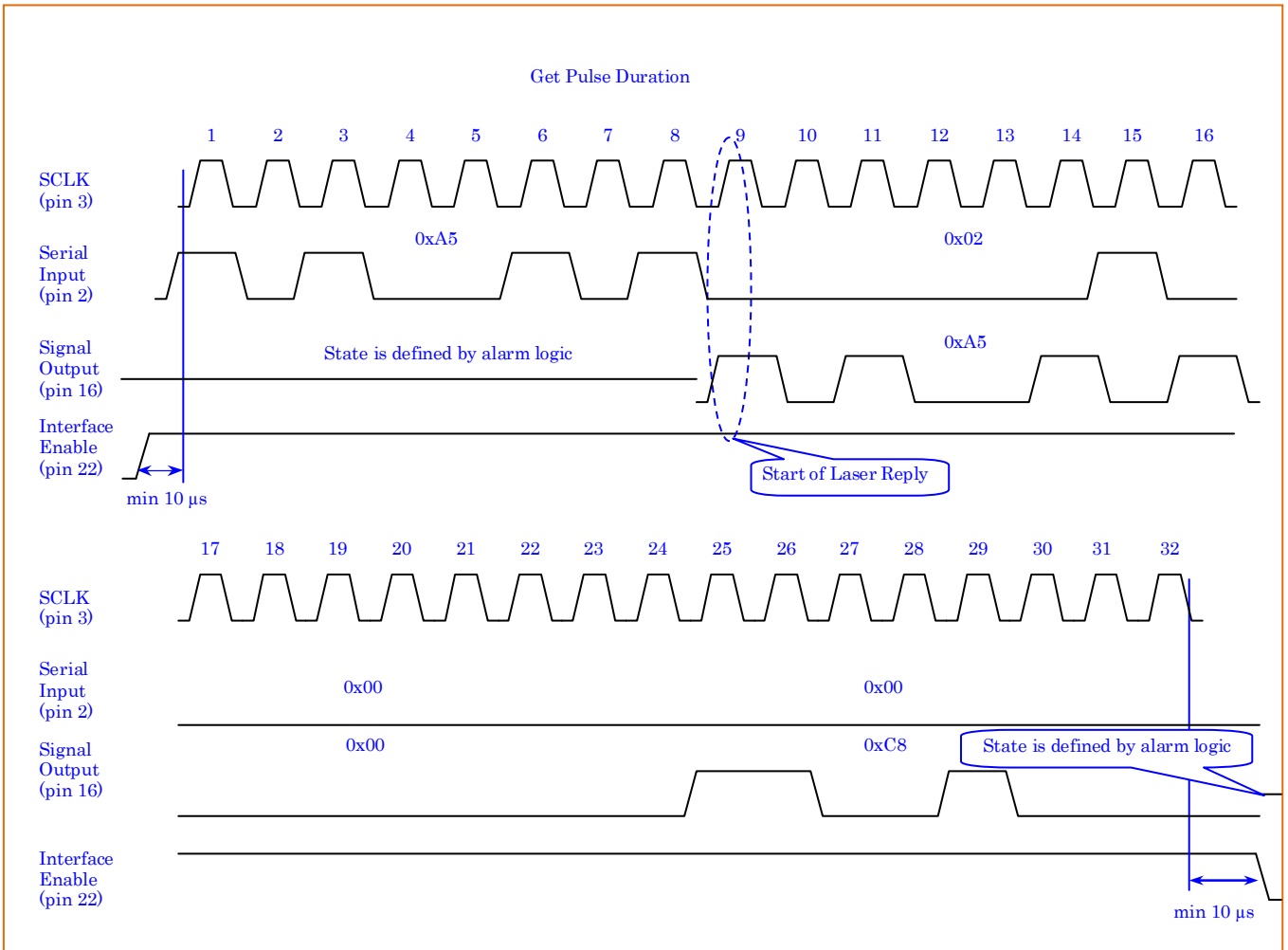

RS-232C electrical connector

RS-232C connector is the DB9 type plug (male). The RS-232C interface is galvanically isolated from the internal laser ground and digital interface. This helps to avoid major problems associated with current loops in complex interface interconnections.

Pin assignment is shown in the table below and is standard for communication with a PC COM port. **Use crossed RS-232C cable to link the laser and a PC.**

PIN No.	Description
1, 4, 6-9	Not connected
2	RxD, receive
3	TxD, transmit
5	Interface ground, galvanically isolated from the laser internal ground

RS-232C Command Structure Description

1. Initialization of RS-232:

speed: 57600 bits per second

parity / flow control: none

start / stop bits: 8 data bits, 1 start bit and 1 stop bit

2. Firmware command structure (ASCII codes for symbols):

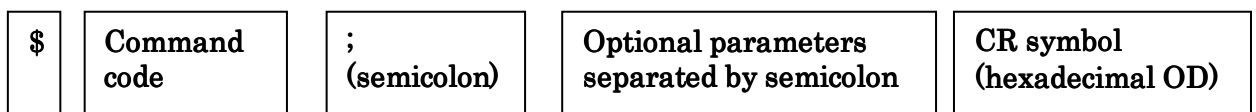

3. Laser reply structure:

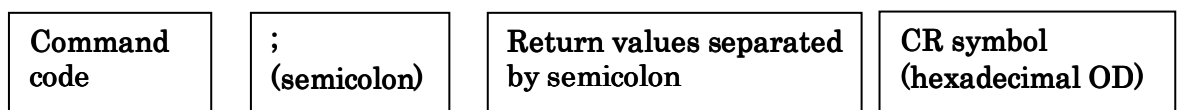

4. The command code is a decimal ASCII representation of a number individual for each command. The list of command numbers is shown in the table below.

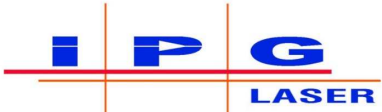
	Interface Specification YLP series Ytterbium Pulsed Fiber Lasers Interfaces “type D” and “type D1”	Spec: Revision: Date: Page:	E27043 02 16.01.09 21 of 29
-----------------------------------------------------------------------------------	-------------------------------------------------------------------------------------------------------------------	--------------------------------------	--------------------------------------

5. Command parameter is a text string. If the parameter is a numerical value, it should be converted into a decimal ASCII string.
6. The returned value is also a text string. If the requested value is numerical, the opposite conversion from text string to the numerical value is required.
7. All commands should be terminated by “Carriage Return” symbol, hexadecimal value “0D”. The RS-232C buffer of the laser receives bytes until the CR symbol occurs. All bytes before this symbol are interpreted as a command. Bytes after CR until next CR will be interpreted as a next command.
8. For all “set” commands device returns as the parameter “Y” if the command was successfully executed and “N” if the command was not executed.
9. For all strings sent to the laser, which were not recognized as valid commands, the laser sends “E” as parameter.
10. After switching on electrical power device state is the following:
 - Pulse repetition rate: nominal PRR
 - EE and EM are in OFF state
 - Set power is zero

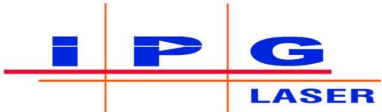
	Interface Specification YLP series Ytterbium Pulsed Fiber Lasers Interfaces “type D” and “type D1”	Spec: Revision: Date: Page:	E27043 02 16.01.09 22 of 29
-----------------------------------------------------------------------------------	-------------------------------------------------------------------------------------------------------------------	--------------------------------------	--------------------------------------

RS-232C Command Codes. Table for monitoring and configuration.

Type	Command	Command code	Parameters or return values	Description/Parameters
Read	Device ID	1	string, up to 24 char	Read device identifier written to the laser in the factory
Read	Device SN	2	string, up to 24 char	Read device serial number
Read	FW revision	3	string, up to 255 char	Read device firmware revision
Read	Vendor	99	string, up to 255 char	Read device vendor written to the laser in the factory
Read	Device Status	4	up to 32 bit integer	Read device status, decimal to binary decoding is required
Read	Device temperature	5	float, 1 digit after point	Read module temperature in degree Celsius
Read	Digital interface Status	10	up to 32 bit integer	Reads digital interface status, decimal to binary decoding is required
Read	Extended Status	11	up to 32 bit integer	Read device extended status, decimal to binary decoding is required
Read	BR Counter	12	up to 32 bit integer	Read back reflection counter
Read	Session BR Counter	13	up to 32 bit integer	Read back reflection counter for the current session. The session starts with supplying voltage to the laser module.
Read	Nominal average Power	14	float, 1 digit after point	Read nominal average power of the laser in [W] Return value is float in [W].
Read	Nominal Pulse Duration	15	up to 32 bit integer	Read nominal pulse duration of the laser [ns]
Read	Nominal Pulse Energy	16	float, 2 digit after point	Read nominal pulse energy of the laser [mJ]
Read	Nominal Peak Power	17	float, 1 digit after point	Read nominal peak power of the laser in [kW]. Value is calculated from the nominal energy and the nominal pulse duration.
Read	PRR Range	18	see description	Read pulse repetition rates range. Return value is two floats separated by a semicolon, corresponding to minimum and maximum PRRs in [kHz].

	Interface Specification YLP series Ytterbium Pulsed Fiber Lasers Interfaces “type D” and “type D1”	Spec:	E27043
		Revision:	02
		Date:	16.01.09
		Page:	23 of 29

Type	Command	Command code	Parameters or return values	Description/Parameters
Read	Head Temperature	19	float, 1 digit after point	Read remote head temperature in degree Celsius, if the head is installed
Read	Main Supply Voltage	21	float, 1 digit after point	Read main 24V supply voltage in [V]
Read	24V Housekeeping Voltage	22	float, 1 digit after point	Read 24V housekeeping supply voltage in [V]
Read	Operating Mode	23	16 bit integer	Read active control interface operating mode, decimal to binary decoding is required.
Set	Operating Mode	24	16 bit integer	Set active control interface operating mode, binary to decimal encoding is required.
Read	Installed Options	25	16 bit integer	Read list of installed options and operating modes, decimal to binary decoding is required
Set	Start Operating Mode	26	16 bit integer	Set initial control interface operating mode, binary to decimal encoding is required. This mode becomes active after supplying the laser with electrical power. Value is stored permanently in the laser EEPROM.
Read	Start Operating Mode	27	16 bit integer	Read control interface operating mode, which activates after connecting the laser to the supply voltage. The value is stored permanently in the laser EEPROM, decimal to binary decoding is required
Read	Operating Power [W]	33	float, 1 digit after point	Read back operating power in [W] set by command 32 (in RS-232 mode) or via digital interface (in DB-25 mode), but recalculated into Watts using nominal laser parameters.
Read	Operating Power [%]	34	float, 1 digit after point	Read back operating power in [%] set by command 32 (in RS-232 mode) or via digital interface (in DB-25 mode), but recalculated into [%] using nominal laser parameters.
Read	Operating Pulse Energy	36	float, 2 digit after point	Read operating pulse energy in [mJ]. Value is calculated using nominal laser parameters and power settings.
Read	PRR monitor	38	float, 1 digit after point	Read back operating PRR in [kHz] set by command 28 (in RS-232 mode) or applied via pin 20 of digital interface (in DB-25 mode)

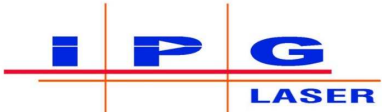
	Interface Specification YLP series Ytterbium Pulsed Fiber Lasers Interfaces “type D” and “type D1”	Spec: Revision: Date: Page:	E27043 02 16.01.09 24 of 29
-----------------------------------------------------------------------------------	-------------------------------------------------------------------------------------------------------------------	--------------------------------------	--------------------------------------

RS-232C Command Codes. Table for RS-232C control interface mode.

Type	Command	Command code	Parameters or return values	Description/Parameters
Set	PRR	28	float, 1 digit after point	Set operating pulse repetition rate in [kHz]
Read	PRR	29	float, 1 digit after point	Read back operating pulse repetition rate in [kHz] set by command 28
Set	Laser Emission ON	30		Command to switch ON laser emission
Set	Laser Emission OFF	31		Switch OFF laser emission.
Set	Operating Power	32	float, 1 digit after point	Set operating power in [%]. Range 0...100, resolution 255 levels for full scale
Set	Guide Laser ON	40		Switch ON guide laser
Set	Guide Laser OFF	41		Switch OFF guide laser.
Set	Reset Alarms	50		Reset alarms, see alarms description for details
Set	Save Parameters	54		Permanently save parameters to EEPROM: 1) preset pulse duration

Command \$30 “Laser Emission ON” cannot switch ON optical emission if the status bit “Laser is ready for emission” is not HIGH. In this case the reason of the not ready state (like active state of guide laser, etc.) should be eliminated and “Laser emission OFF” command should be sent to reset “not ready” state.

RS-232C Command Codes. Table for Extended PRR mode.

Type	Command	Command code	Parameters or return values	Description/Parameters
Read	min/max PRR	46	see description	Read back minimum and maximum operating PRRs. Return value is two float in [kHz] values separated by semicolon.

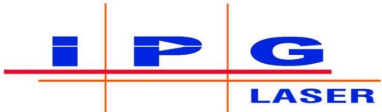
	Interface Specification YLP series Ytterbium Pulsed Fiber Lasers Interfaces “type D” and “type D1”	Spec: Revision: Date: Page:	E27043 02 16.01.09 25 of 29
-----------------------------------------------------------------------------------	-------------------------------------------------------------------------------------------------------------------	--------------------------------------	--------------------------------------

RS-232C Command Codes. Table for Adjustable Pulse Duration mode.

Type	Command	Command code	Parameters or return values	Description/Parameters
Read	Pulse Duration	48	16 bit integer	Read back pulse duration in [ns] set by command 49
Set	Pulse Duration	49	16 bit integer	Set optical pulse duration in [ns]. The set value should correspond to one from the list returned by the command 51
Read	List of Pulse Durations	51	<int1>;<int2>; ...;<intN>	Read list of preset pulse durations in [ns]. List of 16 bit integers separated by semicolon

Command “\$4” “Read device status”- return value interpretation.

Bit	State	Description
0	1 0	Rack reflection Alarm active No BR alarm
1	1 0	Temperature Alarm active. Laser module temperature is out of specified range. No temperature alarm
2	1 0	Temperature Alarm active. Laser remote amplifier temperature is out of specified range. No temperature alarm
3	1 0	System Alarm active No system alarm
4	1 0	24V main supply Alarm active. Overvoltage or Undervoltage of the main electrical supply occurred during the laser emission. No supply alarm
5	1 0	24V housekeeping supply Alarm active. Overvoltage or Undervoltage of the 24V housekeeping electrical supply occurred during the laser emission. No supply alarm
6	1 0	Laser is ready for emission Laser is not ready for emission
7	1 0	At least one of the warnings is activated No warning is activated

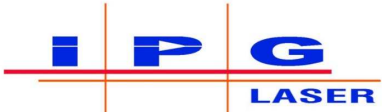
	Interface Specification YLP series Ytterbium Pulsed Fiber Lasers Interfaces “type D” and “type D1”	Spec: Revision: Date: Page:	E27043 02 16.01.09 26 of 29
-----------------------------------------------------------------------------------	-------------------------------------------------------------------------------------------------------------------	--------------------------------------	--------------------------------------

Command “\$10” “Read digital interface DB-25 status”- return value interpretation.

Return bits reflect status of the corresponding pins or internal data.

“1” means that pin/data is HIGH, “0” means LOW.

Bit	Pin/Data	Description of Pin/Data
0	pin 9	Latch
1	pin 23	Emergency stop
2	pin 19	Emission Modulation
3	pin 22	Guide laser control
4	pin 20	External Synchronization
5	pin 18	Emission enable
6	Reserved	Bit is reserved for future use
7	Reserved	Bit is reserved for future use
8	pin 16	Alarm0
9	pin 21	Alarm1
10	pin 11	Alarm2
11	Reserved	Bit is reserved for future use
12	Reserved	Bit is reserved for future use
13	Reserved	Bit is reserved for future use
14	Reserved	Bit is reserved for future use
15	Reserved	Bit is reserved for future use
16	Latched D0	D0 latched power setting
17	Latched D1	D1 latched power setting
18	Latched D2	D2 latched power setting
19	Latched D3	D3 latched power setting
20	Latched D4	D4 latched power setting
21	Latched D5	D5 latched power setting
22	Latched D6	D6 latched power setting
23	Latched D7	D7 latched power setting
24	pin 1	D0 power setting
25	pin 2	D1 power setting
26	pin 3	D2 power setting
27	pin 4	D3 power setting
28	pin 5	D4 power setting
29	pin 6	D5 power setting
30	pin 7	D6 power setting
31	pin 8	D7 power setting

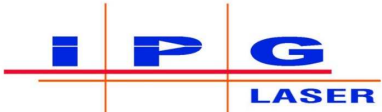
	Interface Specification YLP series Ytterbium Pulsed Fiber Lasers Interfaces “type D” and “type D1”	Spec: Revision: Date: Page:	E27043 02 16.01.09 27 of 29
-----------------------------------------------------------------------------------	-------------------------------------------------------------------------------------------------------------------	--------------------------------------	--------------------------------------

Command “\$11” “Read device extended status”- return value interpretation.

Bit	State	Description	Message Type
0	1 0	Emergency stop was activated Emergency stop was not activated	Warning
1	1 0	External synchronization frequency on 20pin is above specification Not above specification	Warning
2	1 0	External synchronization frequency on 20pin is below specification Not below specification	Warning
3	1 0	Laser ON time (pin 19 HIGH state) is lower than specified Not lower than specified	Warning
4	1 0	Laser OFF time (pin 19 LOW state) is lower than specified Not lower than specified	Warning
5	1 0	Guide laser was activated Guide laser was not activated	Warning
6		Reserved	Information
7		Reserved	Information
8	1 0	Laser emission is ON (laser is pumped) Laser emission is OFF (laser is not pumped)	Information
9		Reserved	
10		Reserved	
11	1 0	Laser emission ON command was received by RS232C Laser emission OFF command was received by RS232C This bit is valid in RS-232C control mode only	Information
12	1 0	Guide laser ON command was received by RS232C Guide laser OFF command was received by RS232C This bit is valid in RS-232C control mode only	Information
13	1 0	24V Main supply voltage is in specified range 24V Main supply voltage is not in specified range	Warning
14	1 0	Laser uses 24V housekeeping supply Laser does not use 24V housekeeping supply	Warning/ Information
15	1 0	Laser uses 5V housekeeping supply Laser does not use 5V housekeeping supply	Warning Information

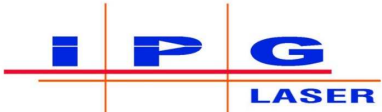
	Interface Specification YLP series Ytterbium Pulsed Fiber Lasers Interfaces “type D” and “type D1”	Spec: Revision: Date: Page:	E27043 02 16.01.09 28 of 29
-----------------------------------------------------------------------------------	-------------------------------------------------------------------------------------------------------------------	--------------------------------------	--------------------------------------

Operating modes commands

Command “\$23” “Read operation mode”- return value interpretation

Command “\$27” “Read start operation mode”- return value interpretation

Command “\$24” “Set operation mode”- value for setting

Command “\$26” “Set start operation mode”- value for setting

Bit	State	Description	Access
0	1 0	DB-25 control interface is active (to activate) Not active (to deactivate)	if installed
1	1 0	RS-232C control interface is active (to activate) Not active (to deactivate)	if installed
2	1 0	Emergency stop pin (pin 23) is in use (to use) Not in use (to not use)	RS-232C control mode only
3	1 0	Guide laser control pin (pin 22) is in use (to use) Not is use (to not use)	RS-232C control mode only
4	1 0	Adjustable pulse duration mode is active (to activate) Not active (to deactivate)	if installed
5		Reserved	
6	1 0	Extended PRR mode is active (to activate) Is not active (to deactivate)	if installed
7	1 0	Emission Modulation pin (pin 19) is in use (to use) Not is use (to not use)	RS-232C control mode only
8	1 0	Jump PRR mode is active (to activate) Jump PRR mode is not active (to deactivate)	if installed
9		Reserved	
10	1 0	Bitstream 1 (BS1) mode is active (to activate) Not active (to deactivate)	if installed
11	1 0	Bitstream (BS) mode is active (to activate) Not active (to deactivate)	if installed

The bits marked as “Reserved” in the structure above are used for internal laser control purpose and are not allowed to be changed by a customer. To preserve these bits first read the status from the laser and then change only required bits keeping other without modification.

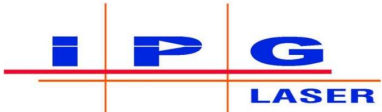
	Interface Specification YLP series Ytterbium Pulsed Fiber Lasers Interfaces “type D” and “type D1”	Spec: Revision: Date: Page:	E27043 02 16.01.09 29 of 29
-----------------------------------------------------------------------------------	-------------------------------------------------------------------------------------------------------------------	--------------------------------------	--------------------------------------

Read options command

Command “\$25” “Read installed options and operating modes”- return value interpretation.

Bit	State	Description
0	1	DB-25 control interface is installed
	0	Not installed
1	1	RS-232C control interface is installed
	0	Not installed
2	1	Extended PRR mode option is installed
	0	Not installed
3	1	Adjustable Pulse Duration option is installed
	0	Not installed
4	1	Optical power monitor is installed
	0	Not installed
5		Reserved
6	1	Remote amplifier is installed
	0	Not installed
7	1	Guide laser is installed
	0	Not installed
8	1	High Contrast (HC) option is installed
	0	Not installed
9		Reserved
10	1	Bitstream 1 (BS1) mode is installed
	0	Not installed
11	1	Bitstream (BS) mode is installed
	0	Not installed